

Antenna review

2.4GHz inverted F antenna on a 0.4mm FR4 PCB

Author: Jonathan Alexander Kreuzeder, intern

31.07.2023

General

Original source of the antenna:

https://github.com/sad-electronics/wch-kicad-lbr/blob/main/footprints/wch-antenna.pretty/ANT-F-1-2.4G-0.4MM-FR4-WCH.kicad_mod

Modified by Xdevelop: No

Simulation software: Dassault Systems CST Studio Suite® 2023

Number of tetrahedrons: 43,998

Matched: No

If you have any questions, contact

Bernhard Wörndl-Aichriedler

bwa@xdevelop.at

PCB data

Stackup:

Layer	Thickness	Material	Dielectric constant ϵ_r
Top	35 μ m	Copper	Not relevant
Core	0.35mm	FR4 (epoxy resin + fiberglass)	4.3
Bottom	35 μ m	Copper	Not relevant

PCB dimensions & layout

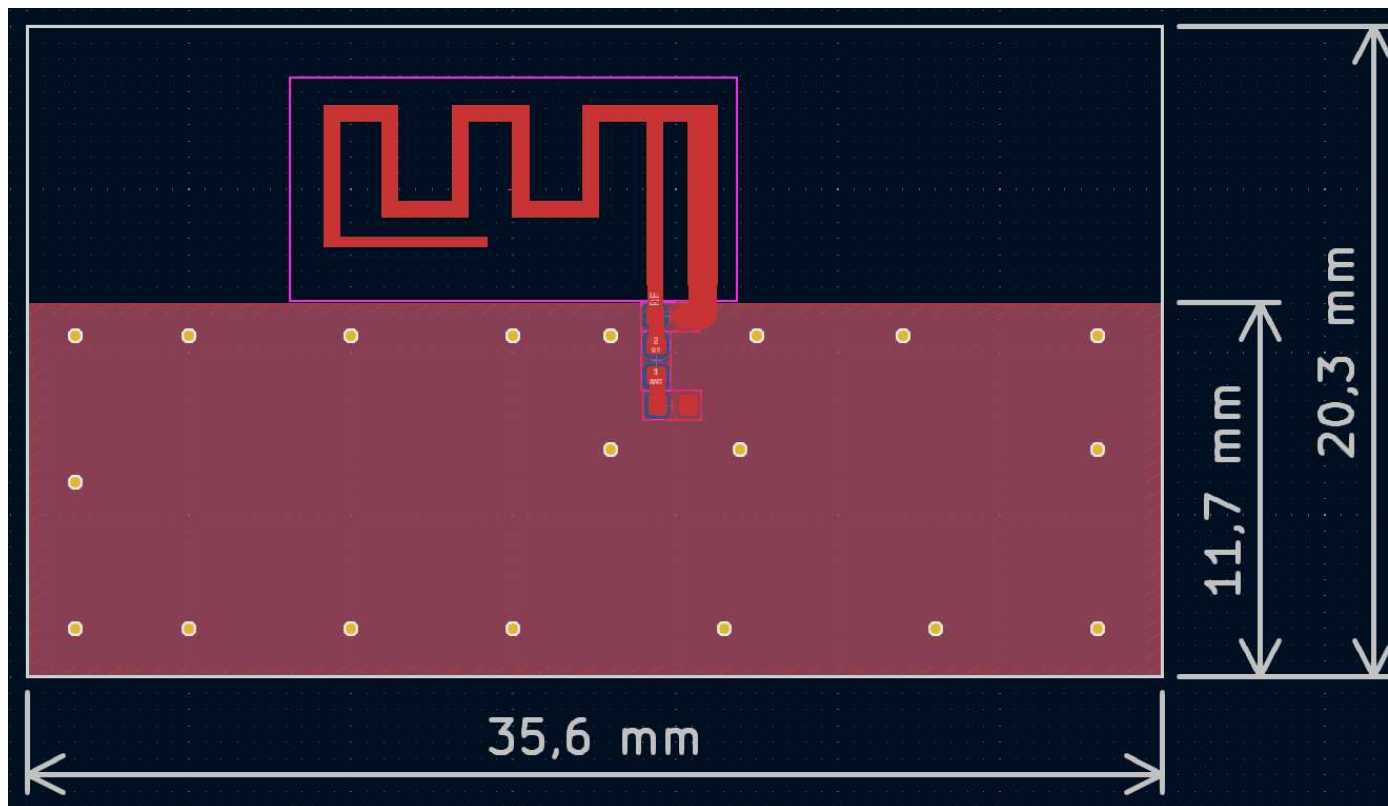

3D model of the PCB from the front

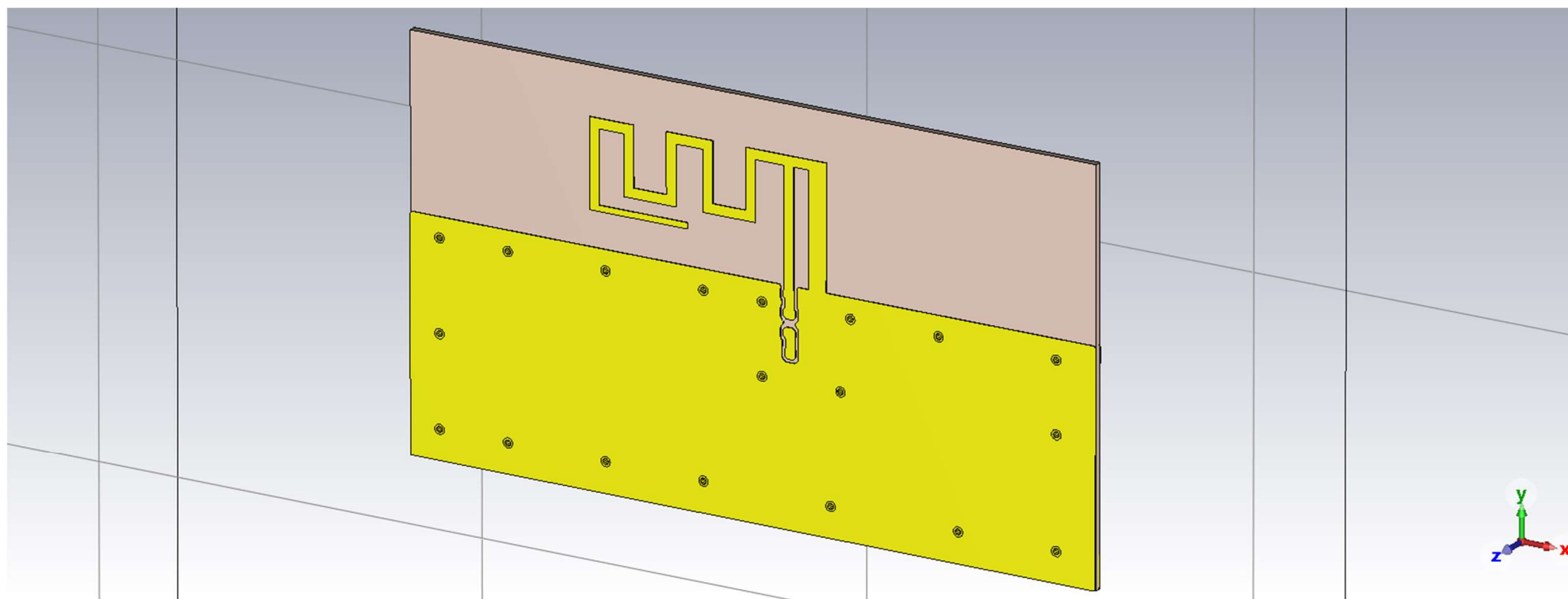

3D model of the PCB from the back

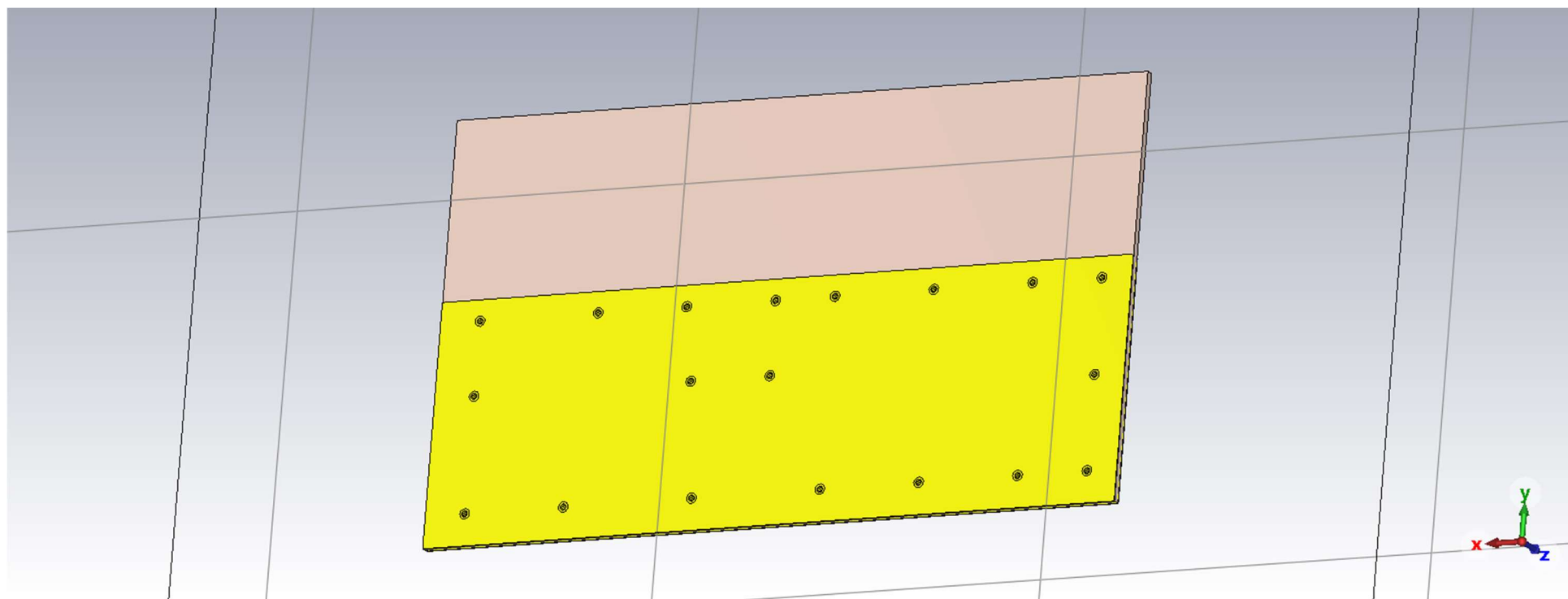

S-parameter

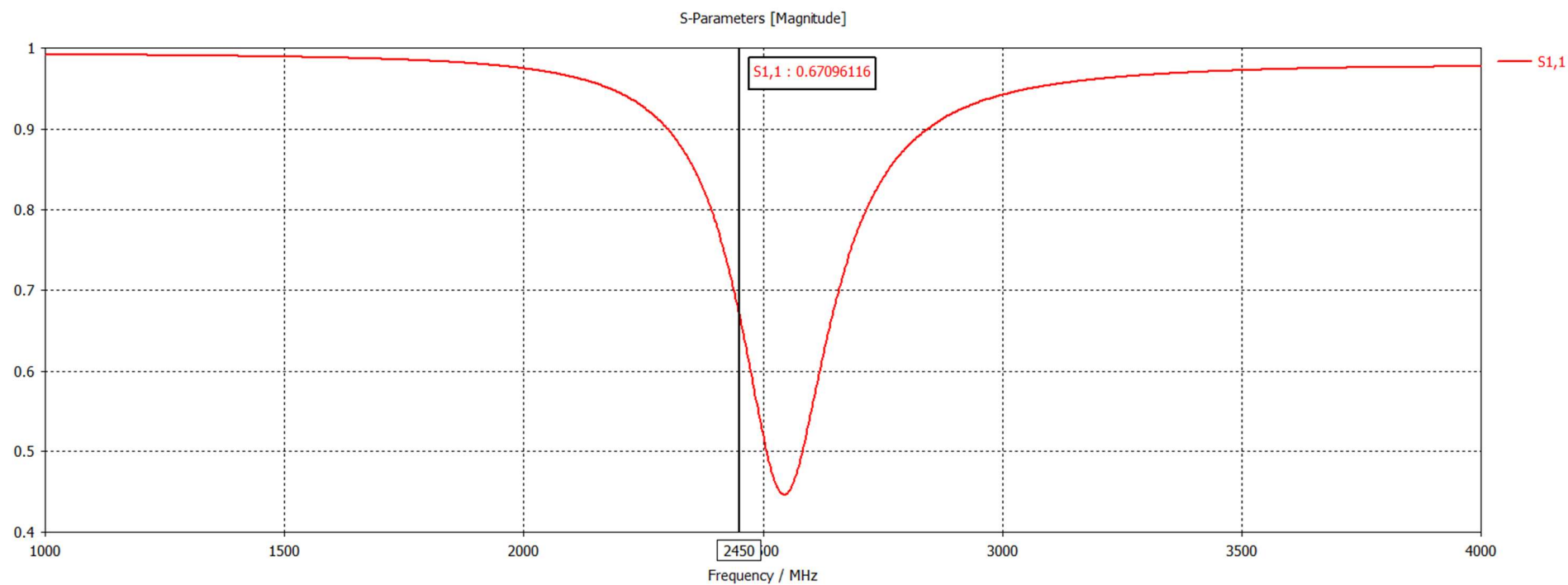

Radiation efficiency

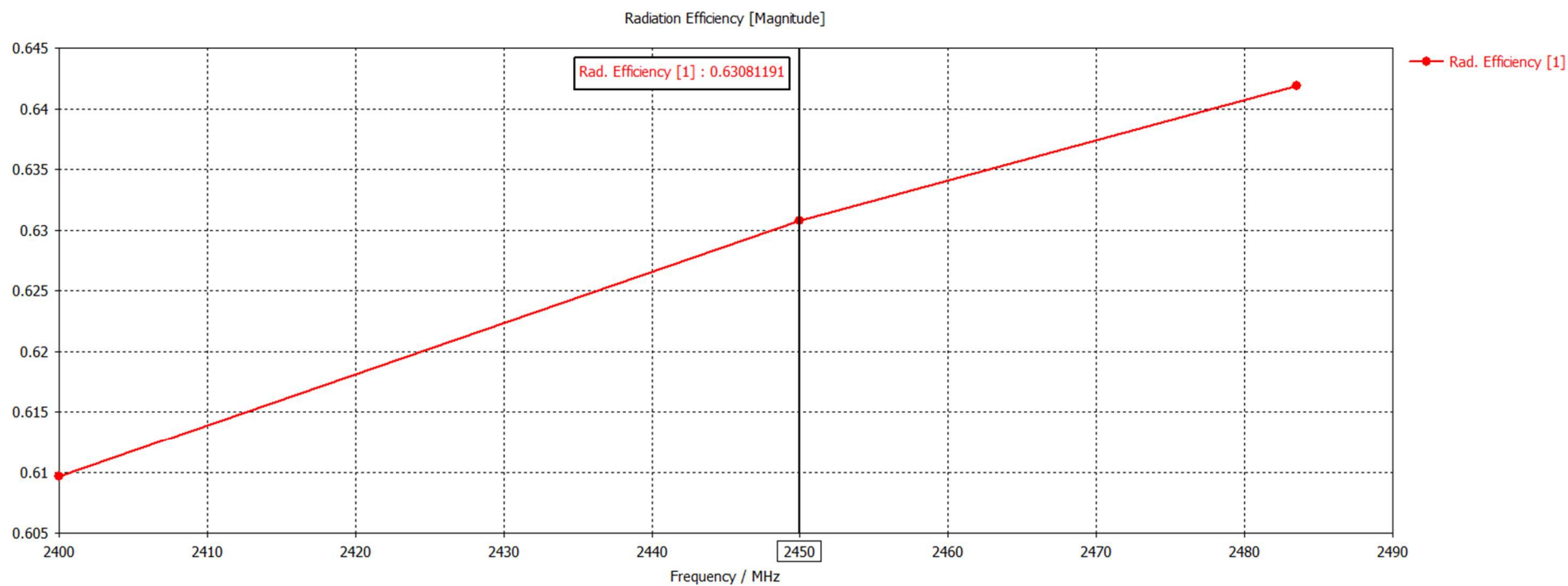

Total efficiency

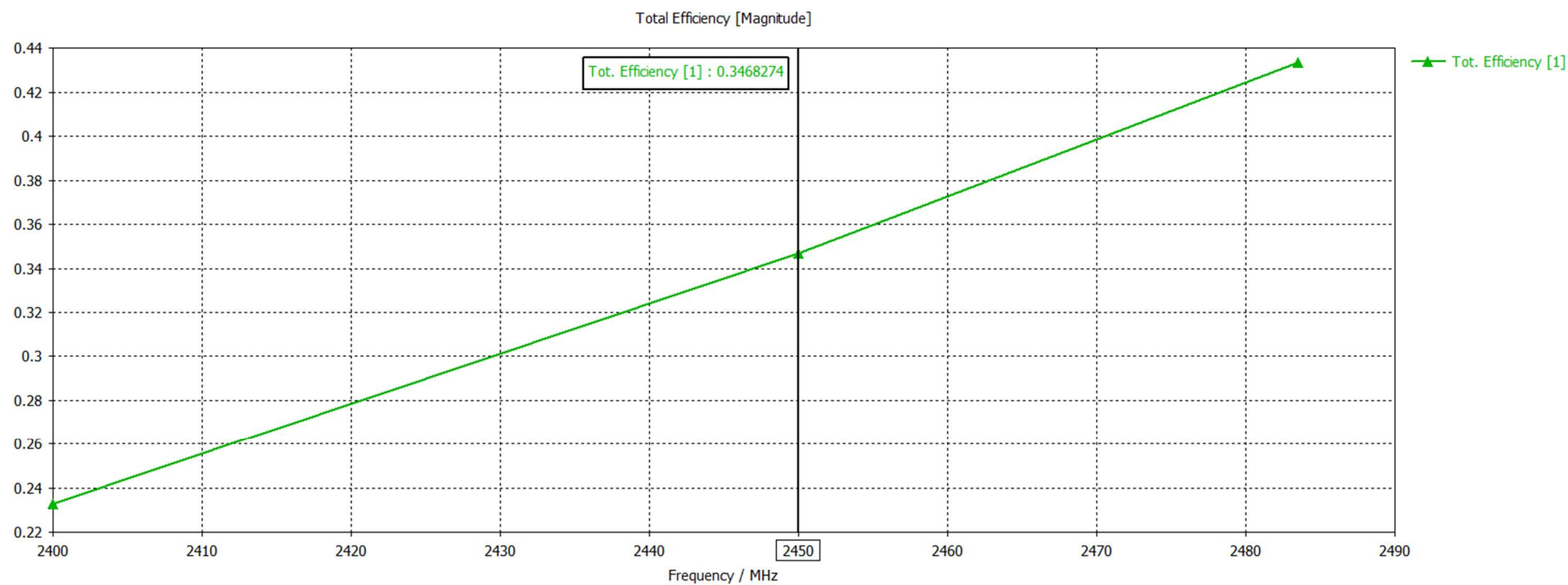

VSWR

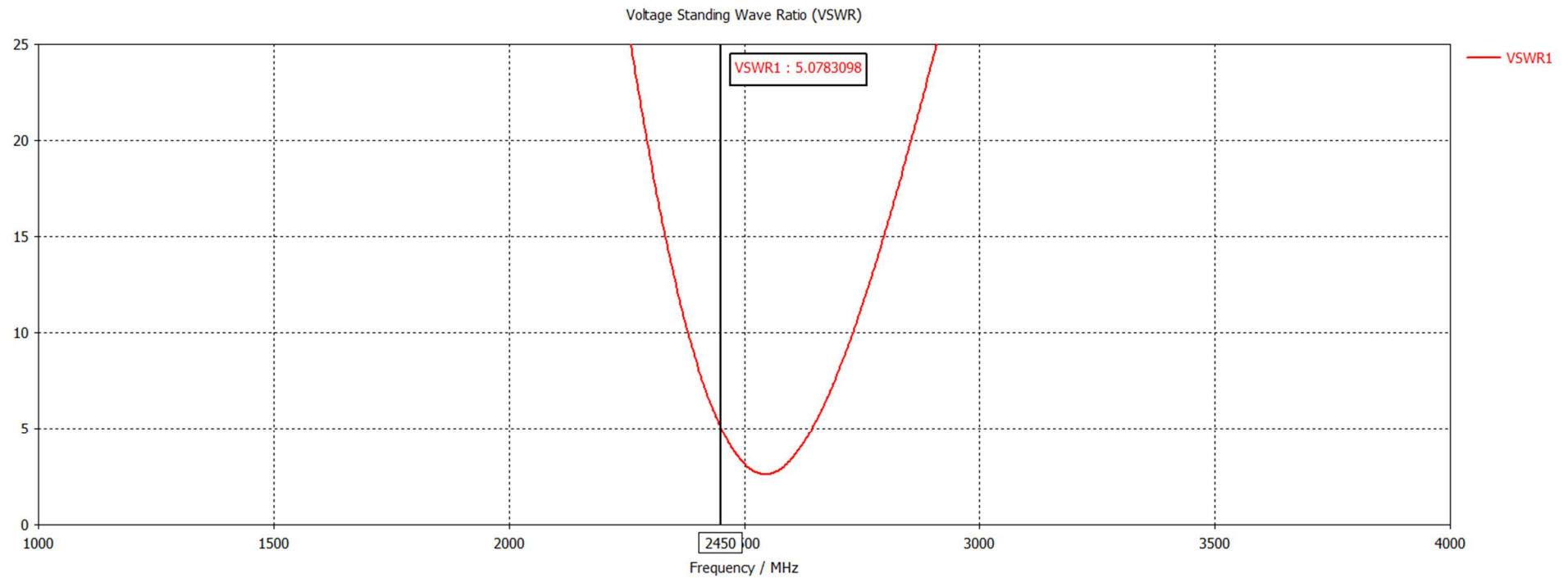

Impedance Z

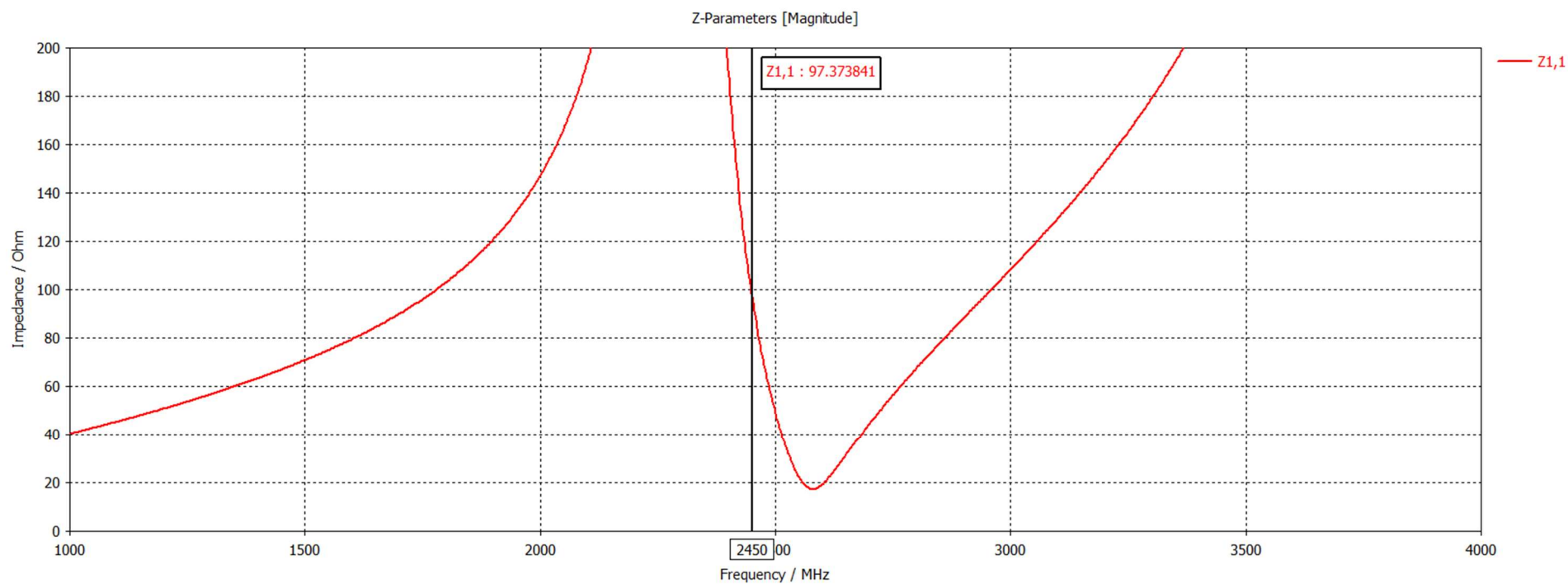

Maximum E-field (front)

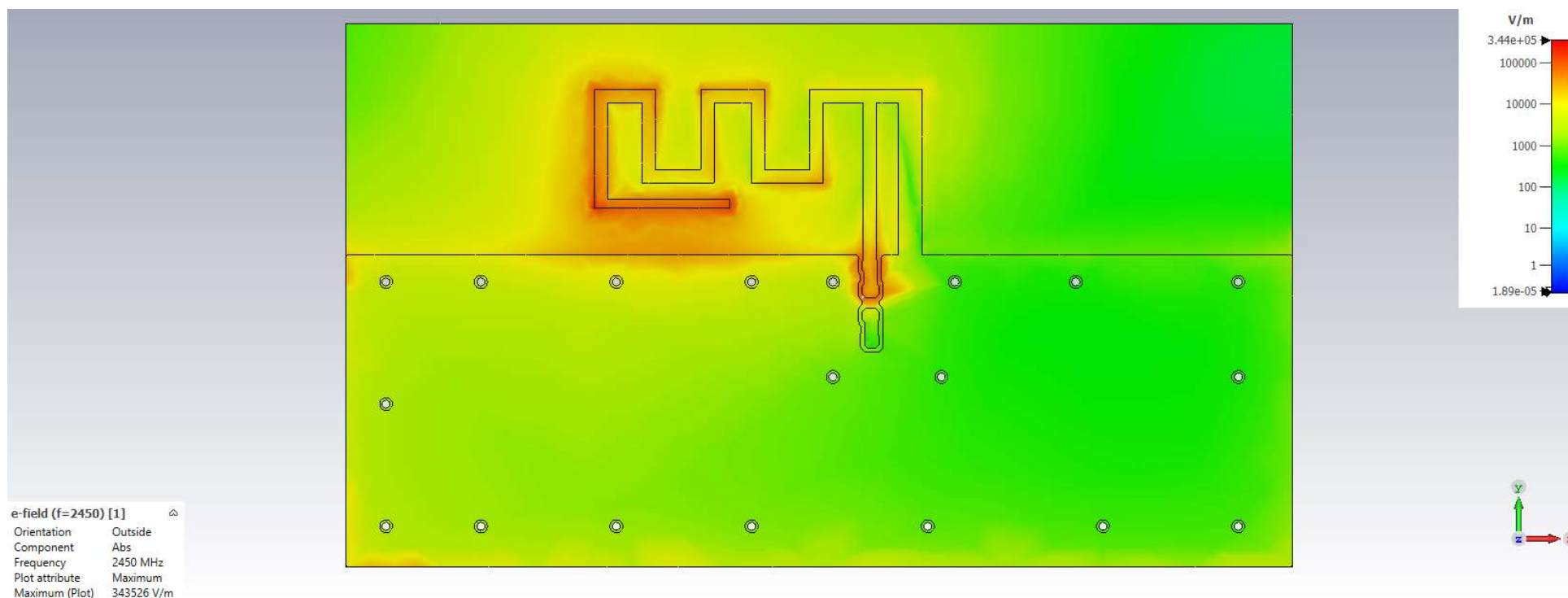

Maximum E-field (back)

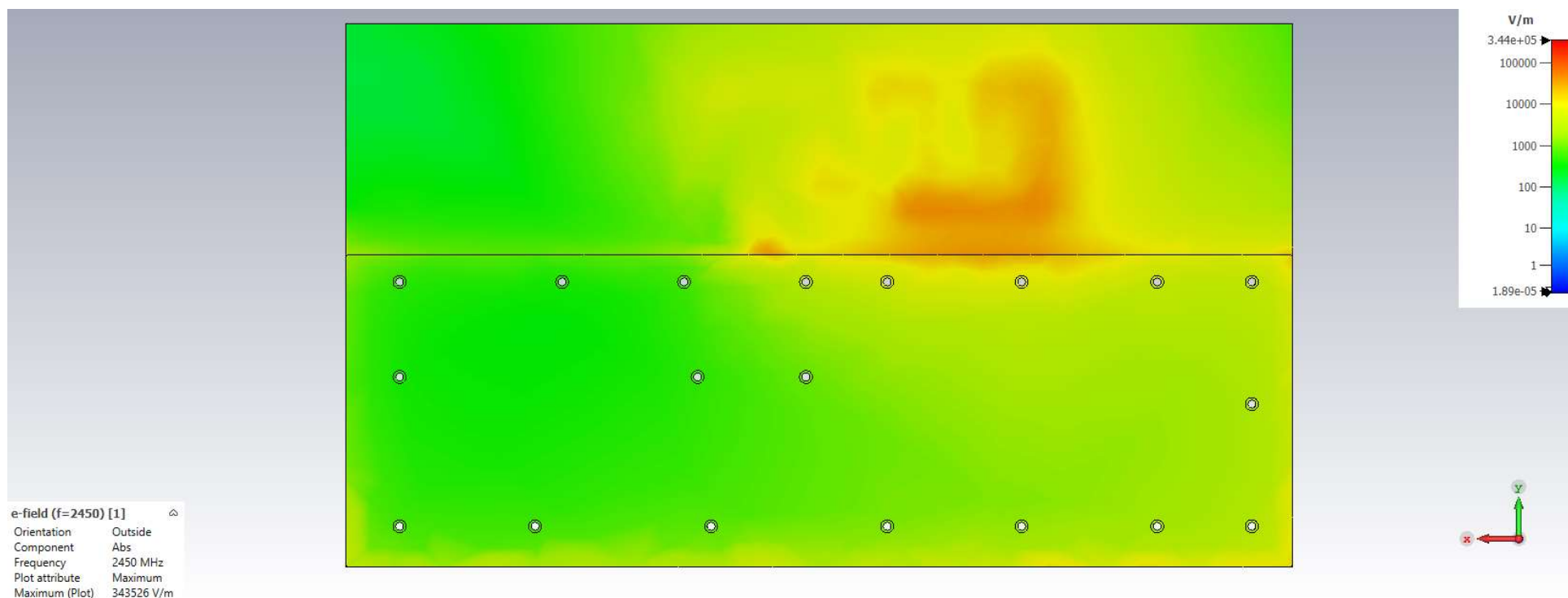

Farfield viewed from the upper edge (-y) of the PCB

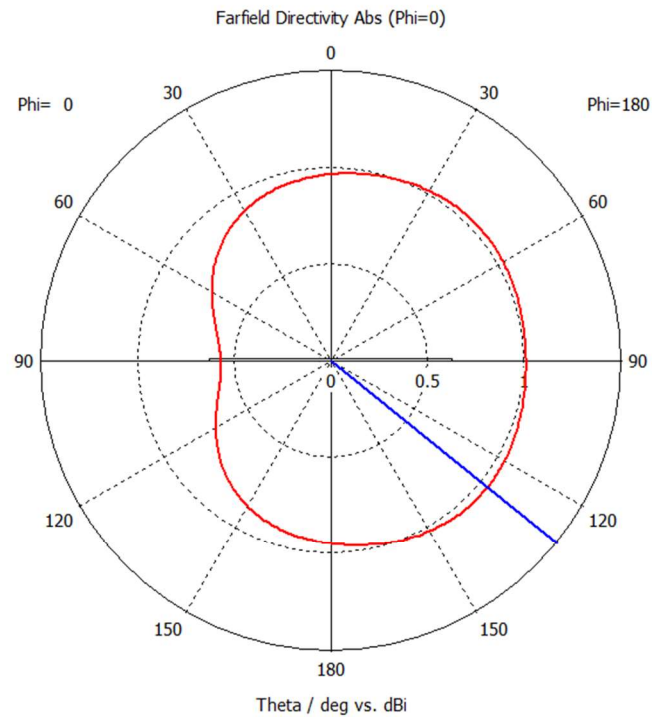

— farfield (f=2450)

Frequency = 2450 MHz
Main lobe magnitude = 1.04 dBi
Main lobe direction = 129.0 deg.

Farfield viewed from the right edge (-x) of the PCB

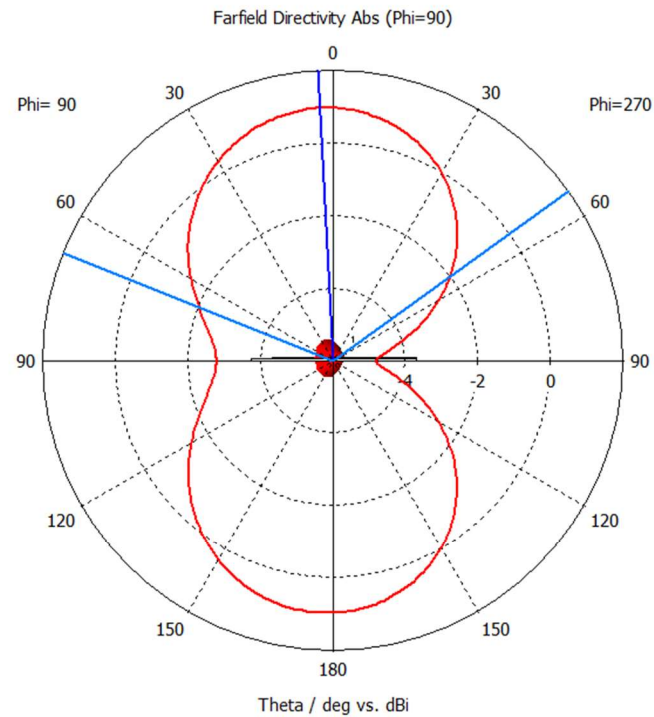

— farfield (f=2450)

Frequency = 2450 MHz
Main lobe magnitude = 0.97 dBi
Main lobe direction = 3.0 deg.
Angular width (3 dB) = 122.4 deg.

Farfield viewed from the top (-z) of the PCB

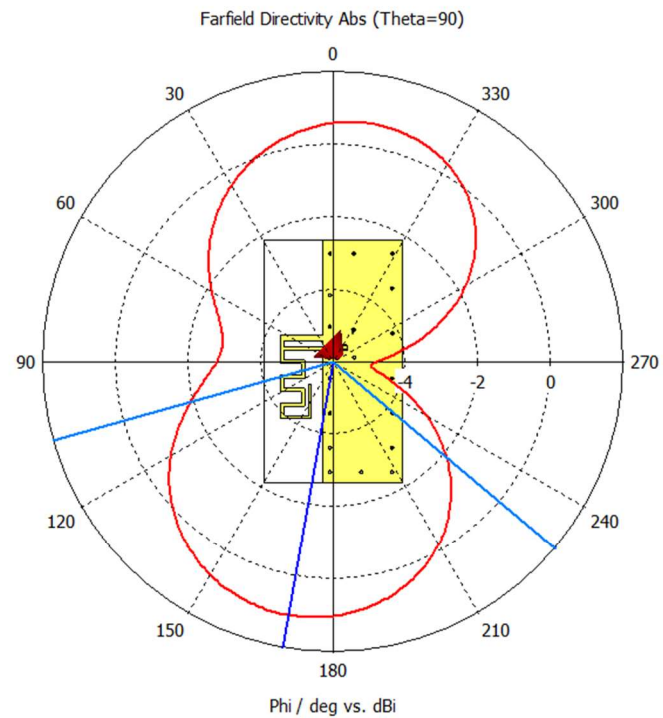

— farfield (f=2450)

Frequency = 2450 MHz
Main lobe magnitude = 1.09 dBi
Main lobe direction = 170.0 deg.
Angular width (3 dB) = 124.2 deg.

3D-Farfield (perspective)

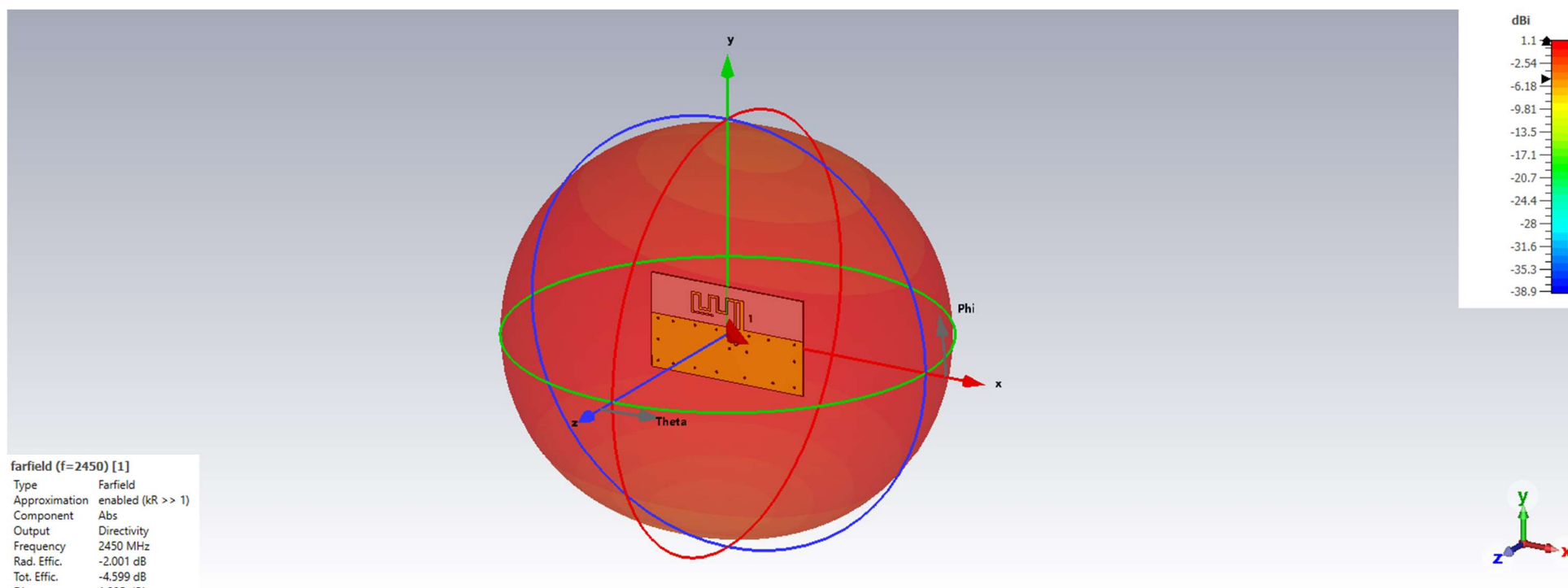

3D-Farfield (perspective)

