

# Antenna review

2.4GHz inverted F antenna on a 1.2mm FR4 PCB

Alternative layout

Author: Jonathan Alexander Kreuzeder, intern

31.07.2023

# General

Original source of the antenna:

[https://github.com/sad-electronics/wch-kicad-lbr/blob/main/footprints/wch-antenna.pretty/ANT-F-2-2.4G-1.2MM-FR4-WCH.kicad\\_mod](https://github.com/sad-electronics/wch-kicad-lbr/blob/main/footprints/wch-antenna.pretty/ANT-F-2-2.4G-1.2MM-FR4-WCH.kicad_mod)

Modified by Xdevelop: No

Simulation software: Dassault Systems CST Studio Suite® 2023

Number of tetrahedrons: 52,733

Matched: No

If you have any questions, contact

*Bernhard Wörndl-Aichriedler*

[bwa@xdevelop.at](mailto:bwa@xdevelop.at)

# PCB data

## Stackup:

Layer	Thickness	Material	Dielectric constant $\epsilon_r$
Top	35 $\mu$ m	Copper	Not relevant
Core	1.13mm	FR4 (epoxy resin + fiberglass)	4.3
Bottom	35 $\mu$ m	Copper	Not relevant

# PCB dimensions & layout

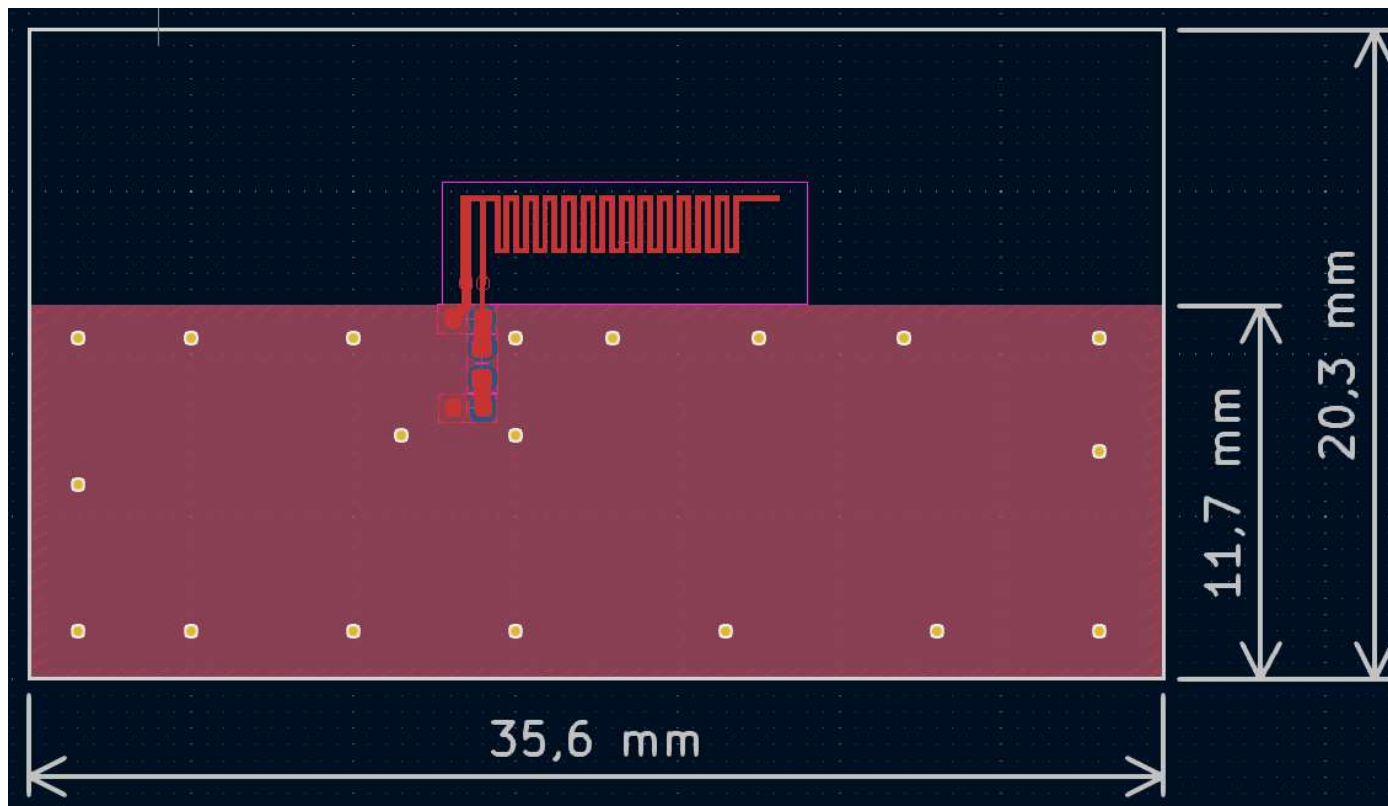

## 3D model of the PCB from the front

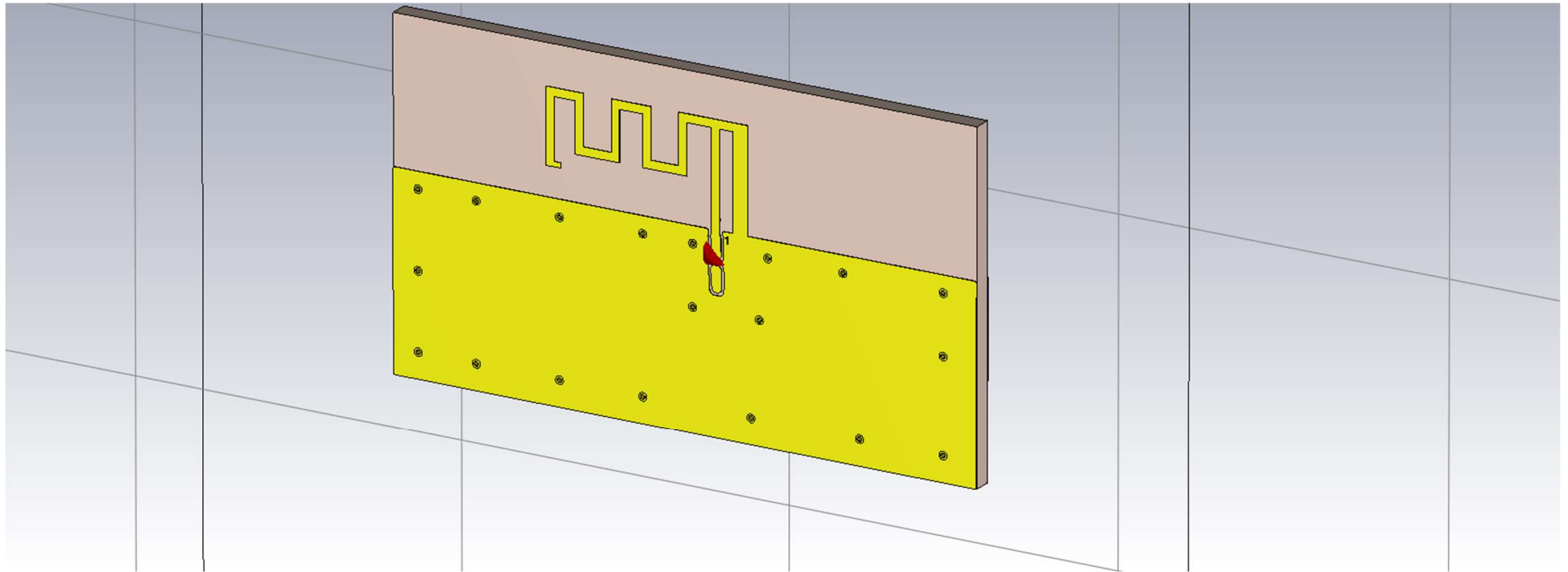

## 3D model of the PCB from the back

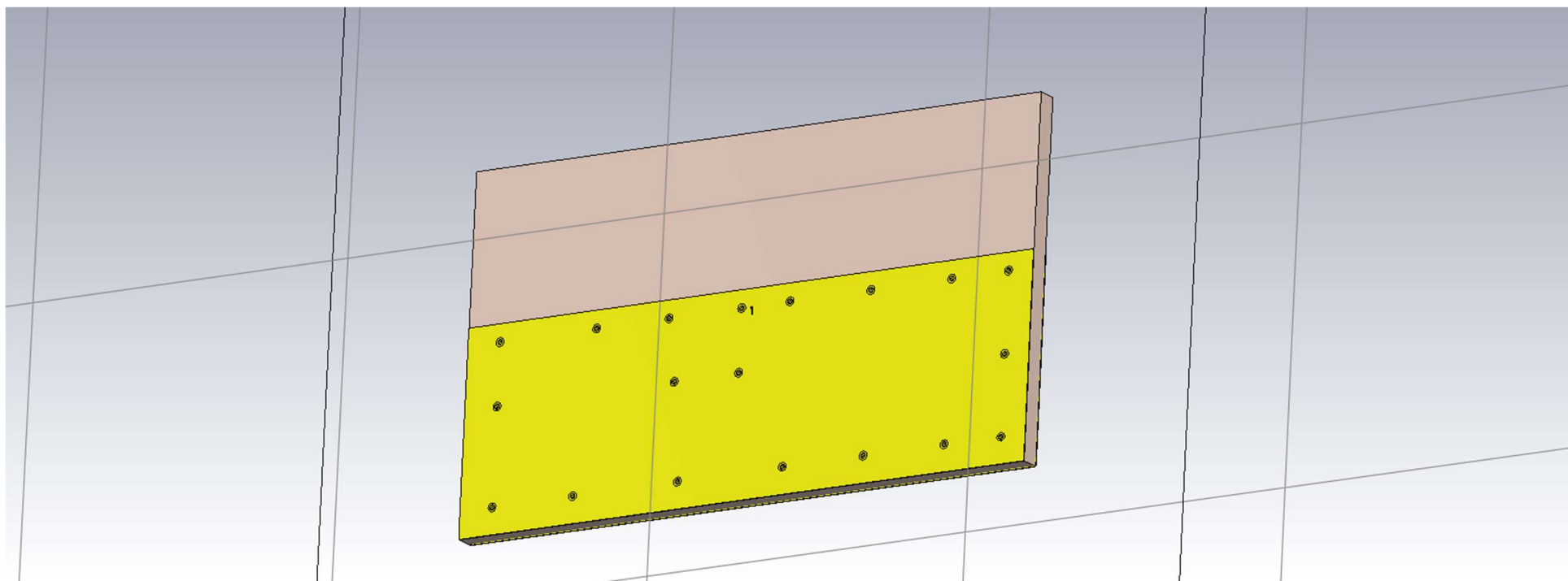

# S-parameter

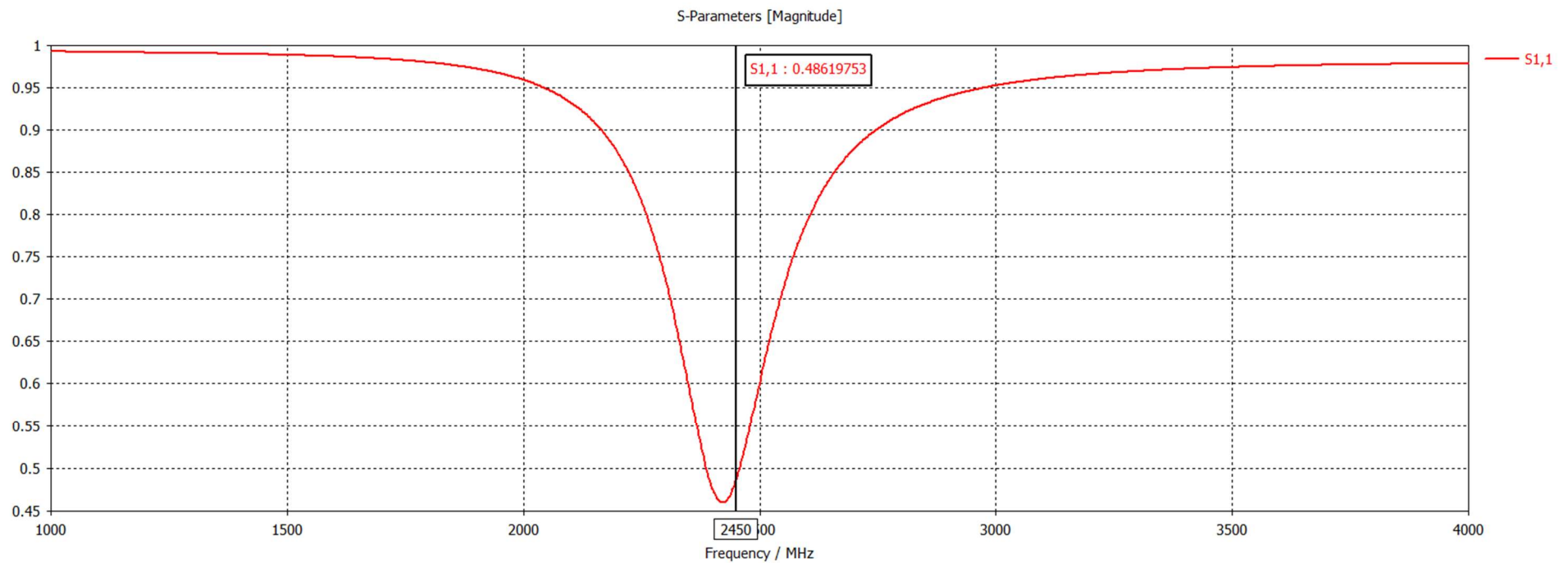

# Radiation efficiency

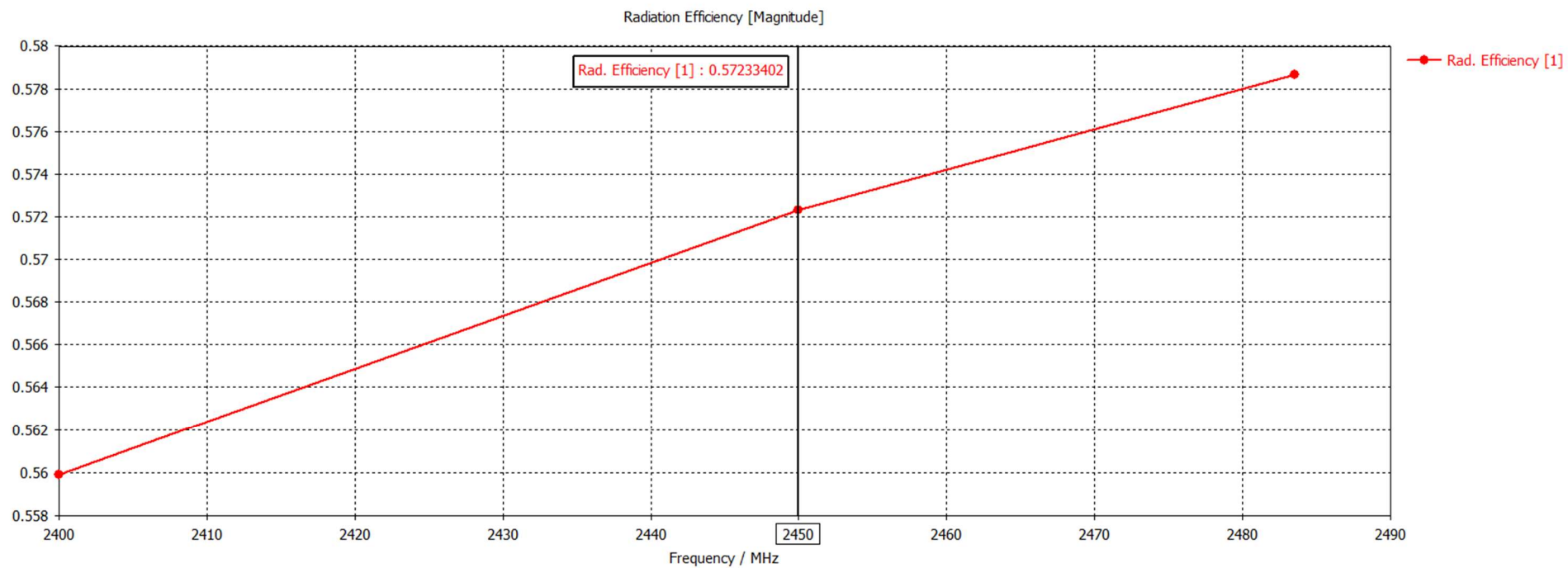



# Total efficiency

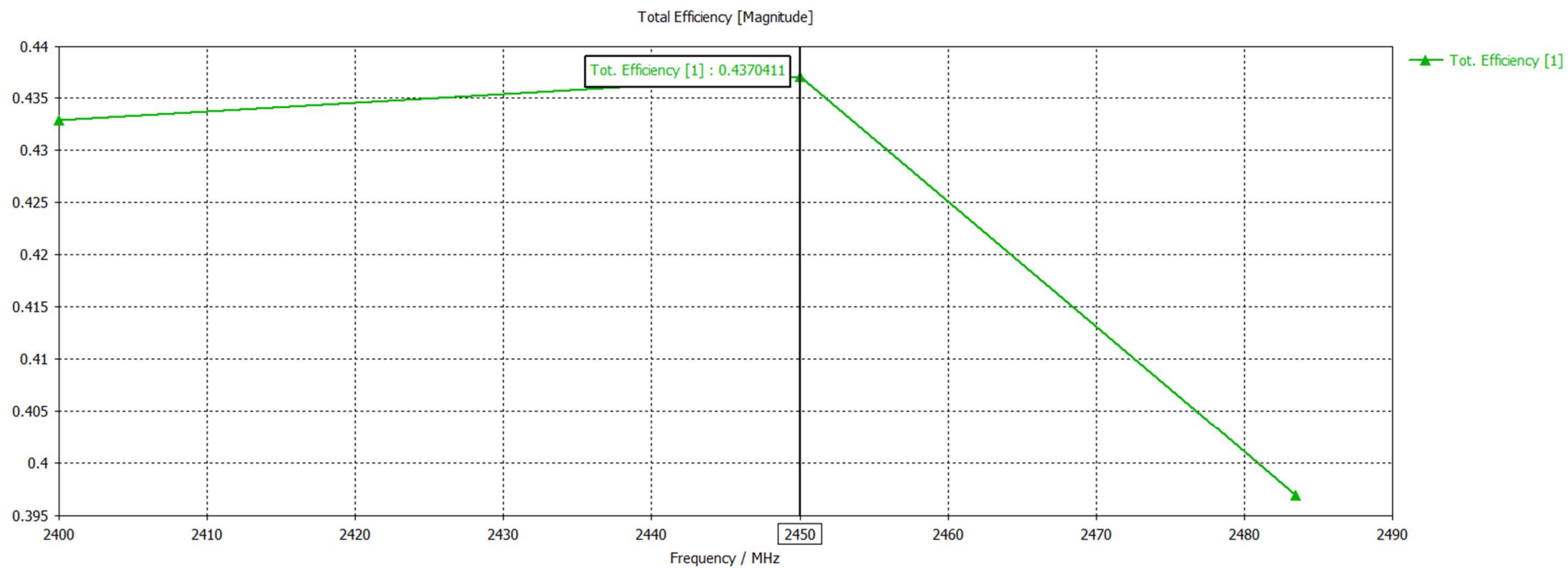

# VSWR

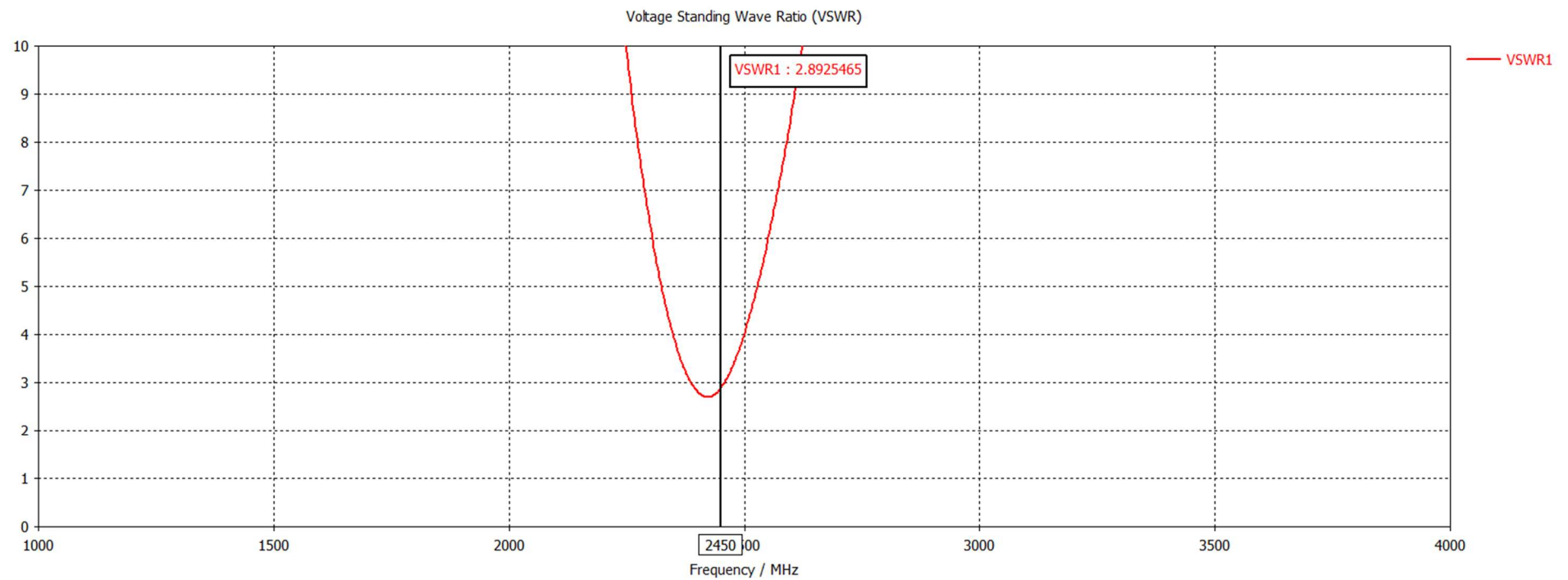

# Impedance Z

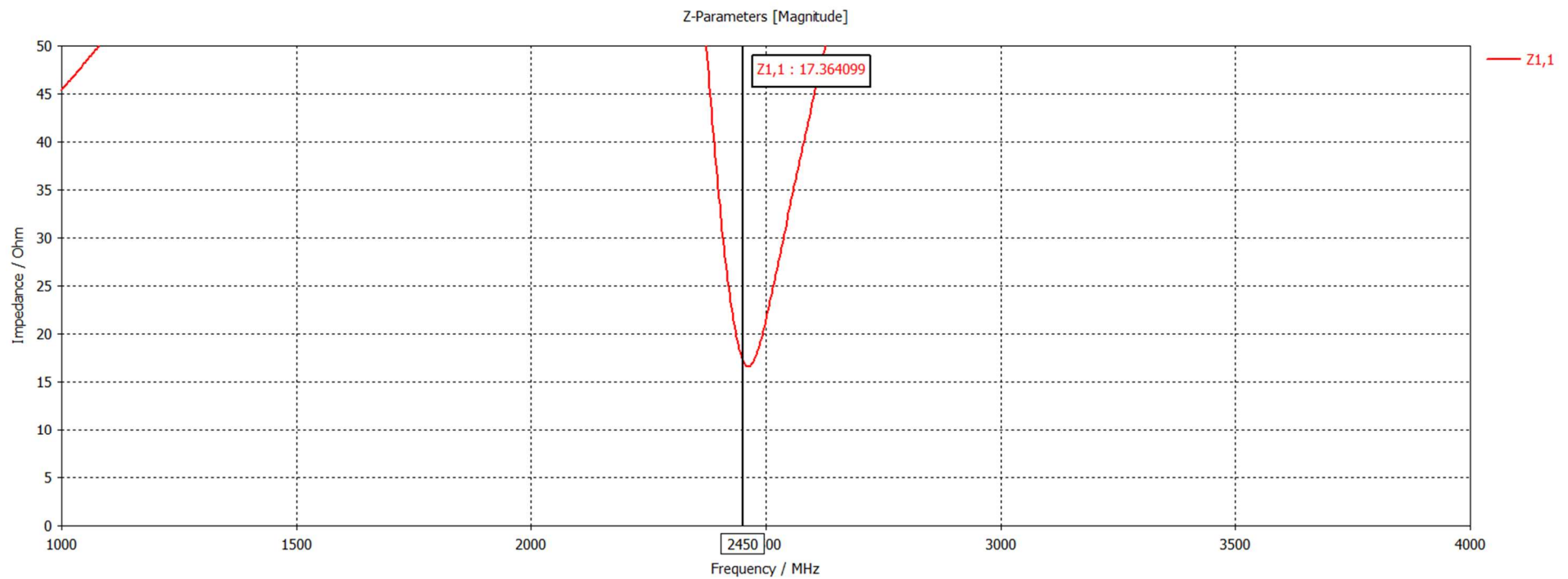

# Maximum E-field (front)

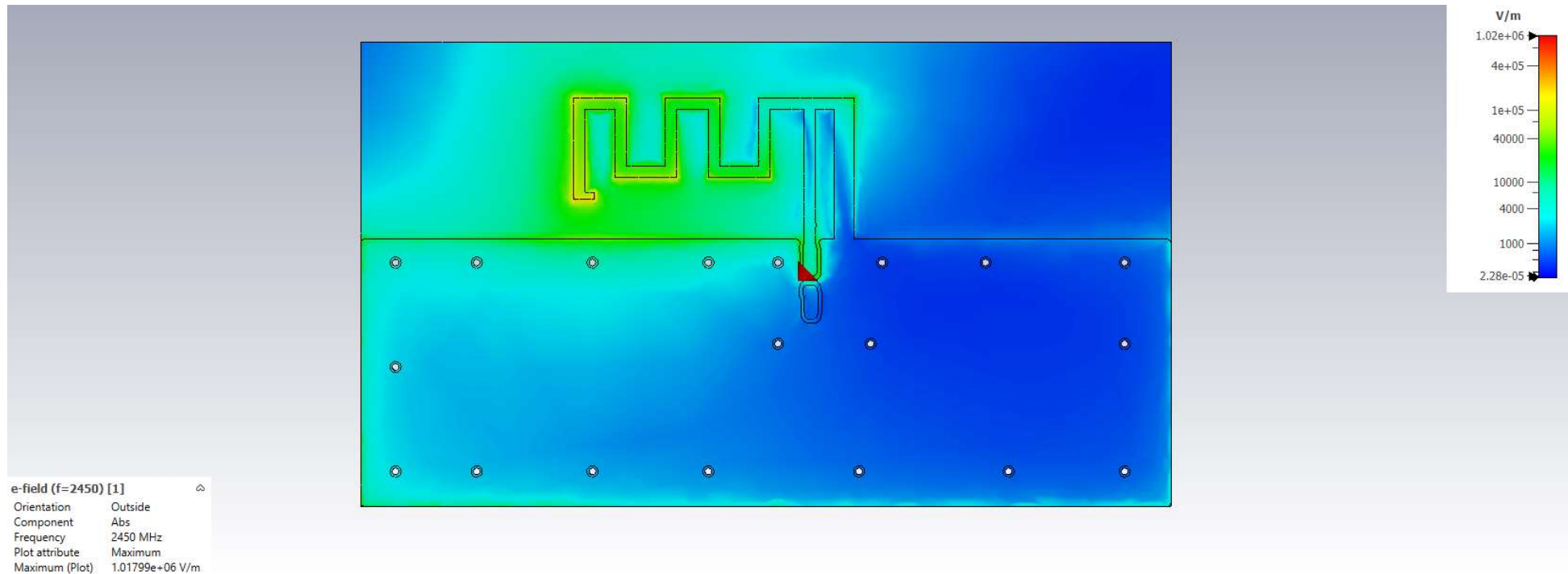

# Maximum E-field (back)

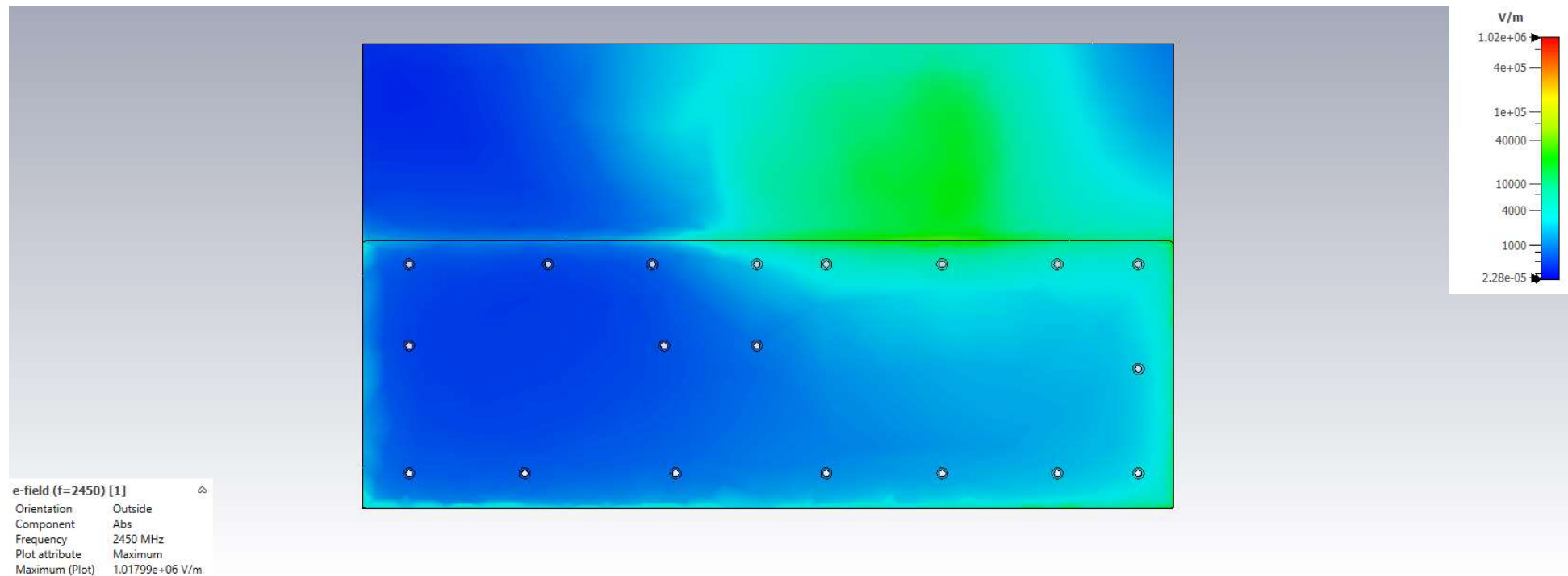

# Farfield viewed from the upper edge (-y) of the PCB

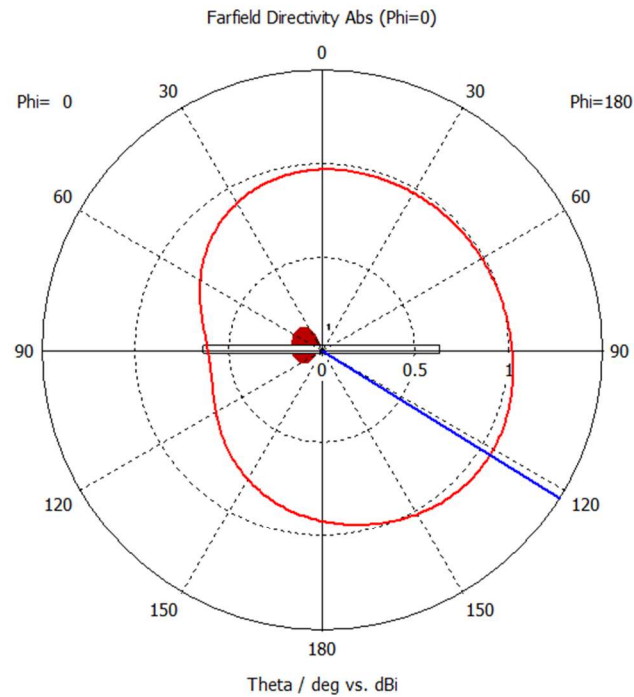

— farfield (f=2450)

Frequency = 2450 MHz  
Main lobe magnitude = 1.06 dBi  
Main lobe direction = 122.0 deg.

# Farfield viewed from the right edge (-x) of the PCB

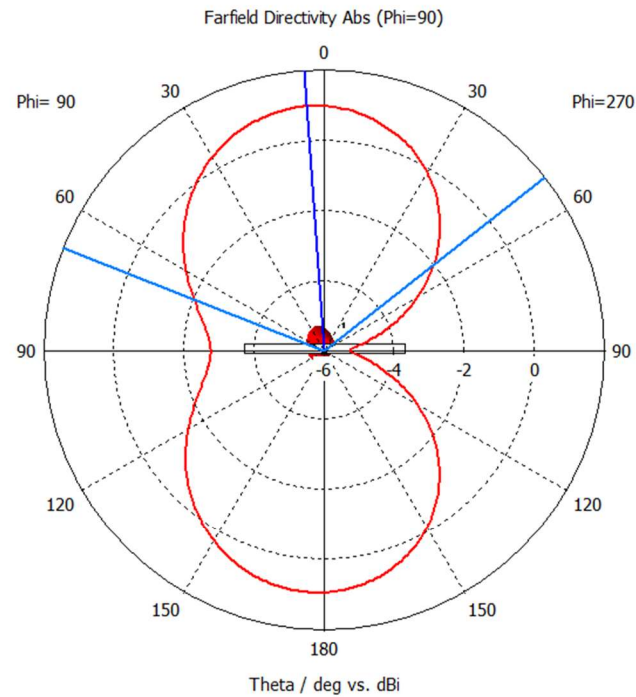

— farfield (f=2450)

Frequency = 2450 MHz  
Main lobe magnitude = 0.98 dBi  
Main lobe direction = 4.0 deg.  
Angular width (3 dB) = 120.4 deg.

# Farfield viewed from the top (-z) of the PCB

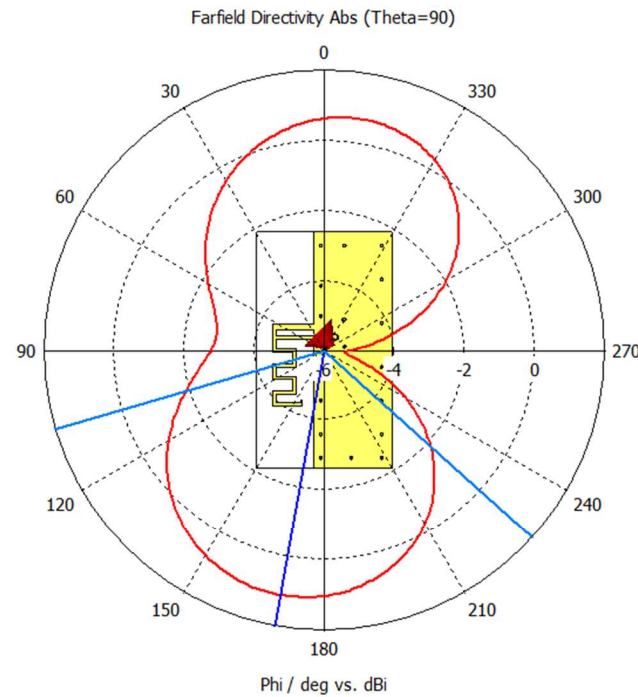

— farfield (f=2450)

Frequency = 2450 MHz  
Main lobe magnitude = 1.1 dBi  
Main lobe direction = 170.0 deg.  
Angular width (3 dB) = 121.6 deg.



# 3D-Farfield (perspective)

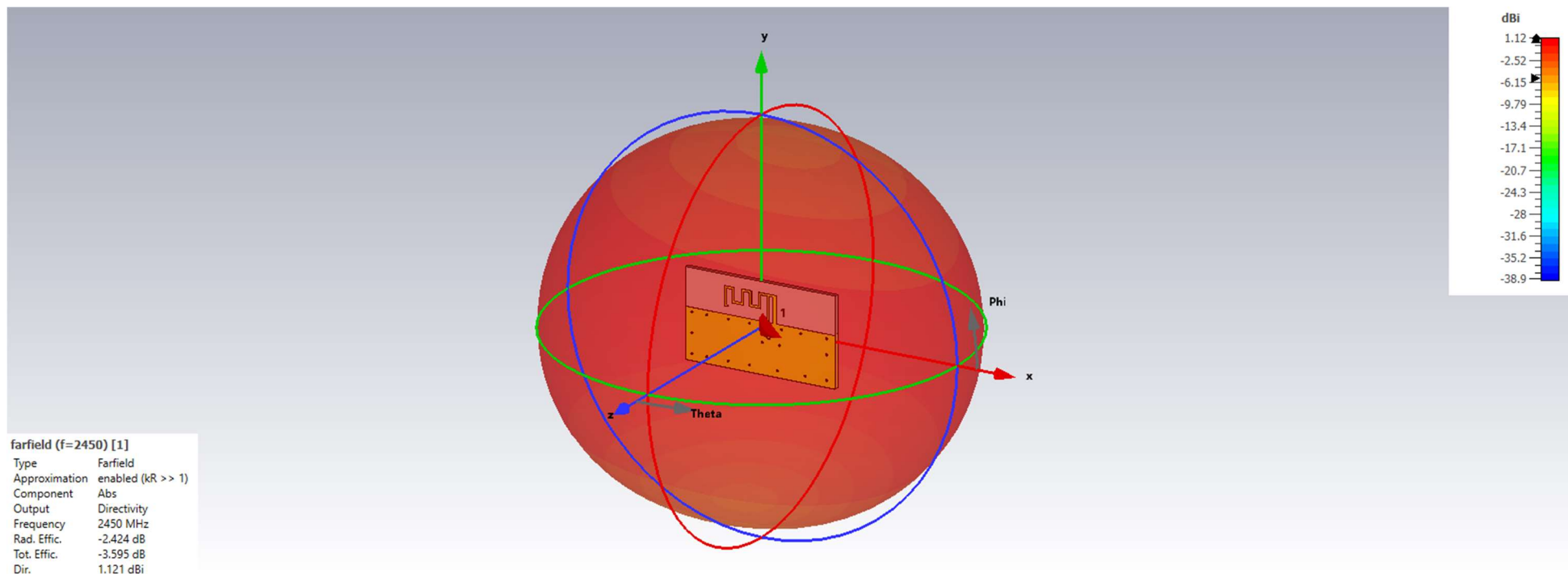

# 3D-Farfield (perspective)

